

HARDWARE INSTRUCTIONS

Warning: Manufacturer's warranty shall be void if product is not installed by a licensed professional.

Prior to commencing installation, please ensure the following:

- the wall where the product is being installed is able to support the weight of the product
- the main electrical supply has been powered off to complete installation
- Green = GROUND wire. connect to the ground wire in your box, or to the box as a ground.
- White = LIVE wire. connect to the White LIVE wire in your box.
- Black = Neutral wire. connect to the Black Neutral wire in your box.

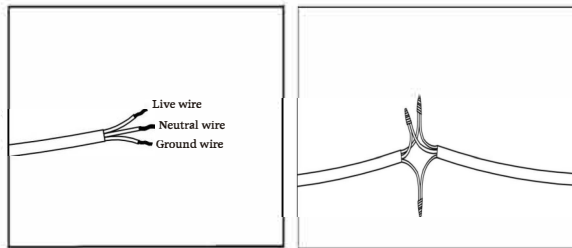

- (1) You would see there three wires with three colors--white, green and black.
- (2) Safely connect these three wires one by one to the wires of wall switch in your home.

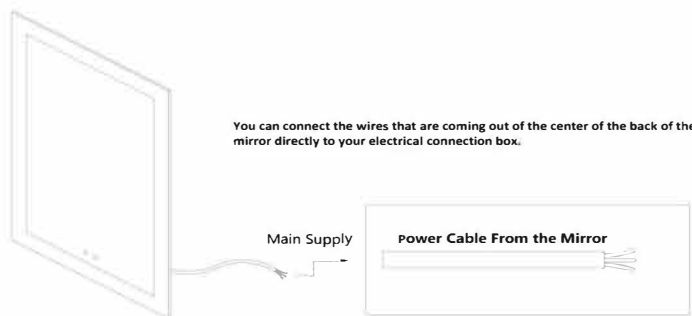

WALL MOUNTING INSTRUCTIONS

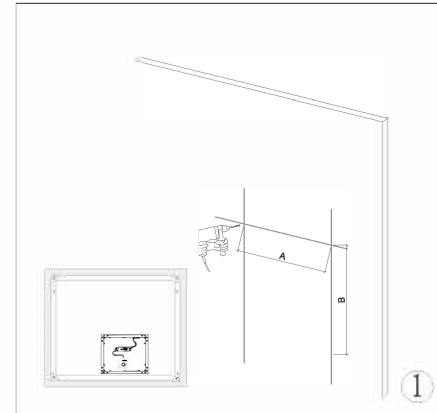

Measure the distance of the mounting hole, Drill holes with a suitable sized drill.

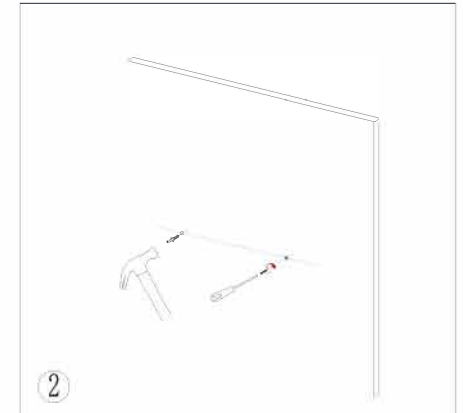

Insert the anchor and mounting screw into the wall.

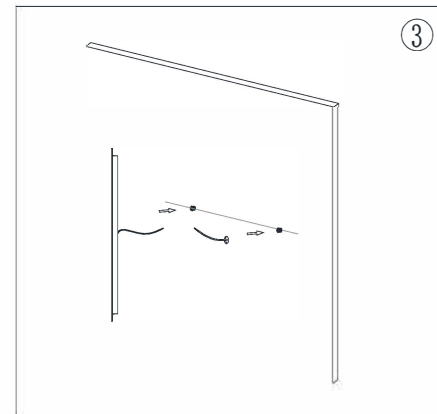

Connect the mirror wires with your main wires and hang the mounting hole to the screw on the wall.

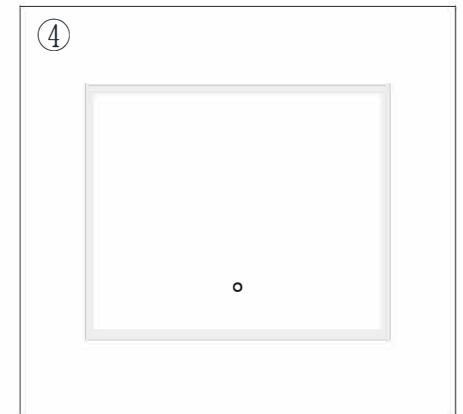

Peel off protective film and clean the mirror with damp cloth.







After care

Never use bleach based or window cleaning solution as these may damage the backing of the mirror. We recommend a damp cloth to remove splashes.

OPERATING INSTRUCTIONS

Button:



-  Touch this button in order to turn the lighting ON/OFF.
Touch and hold this button in order to dim the light intensity.
-  Touch this button in order to turn the defogger ON/OFF
-  Touch this button in order to turn the Bluetooth speaker ON/OFF.
-  Using a short touch this button controls Play and Pause functionalities.
Press and hold this button to engage the clock's program mode. In program mode, the clock will go through all 4 number fields with a 3 second break in between. To set the time, press the button again while the number field is flashing.
-  Touch this button to play next song.
Touch this button and hold for 3 second to make the volume higher.
-  Touch this button to play next song.
Touch this button and hold for 3 second to lower the volume.